

R5-192-CT

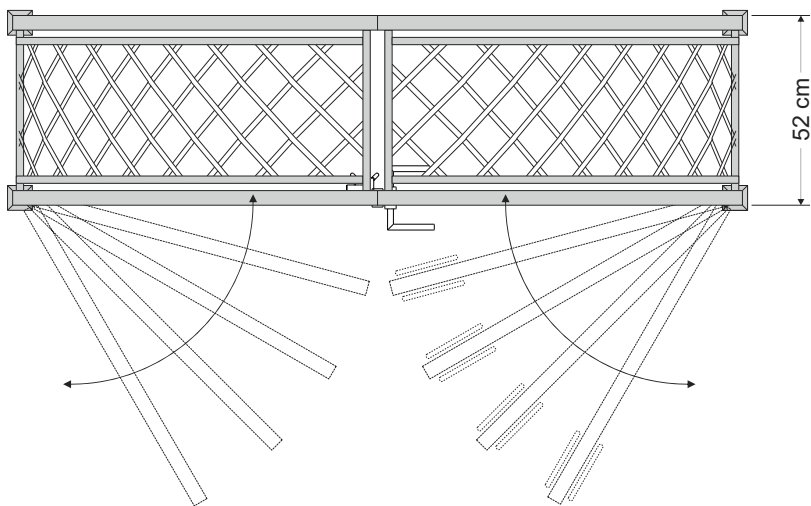

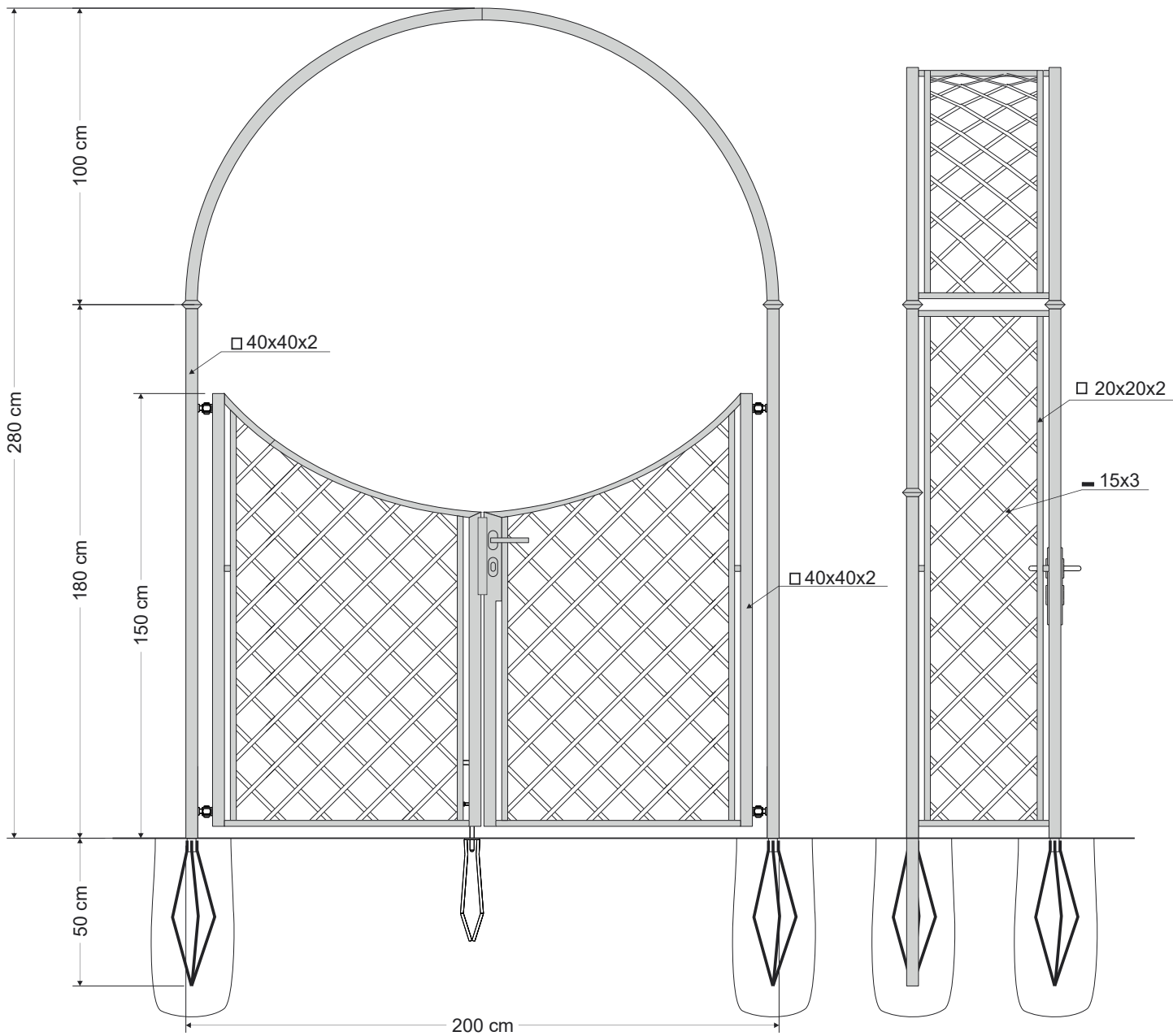

central fixing spike (opened)



central fixing spike (closed)



handle

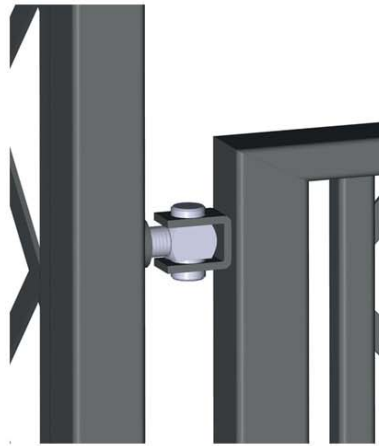

hinge

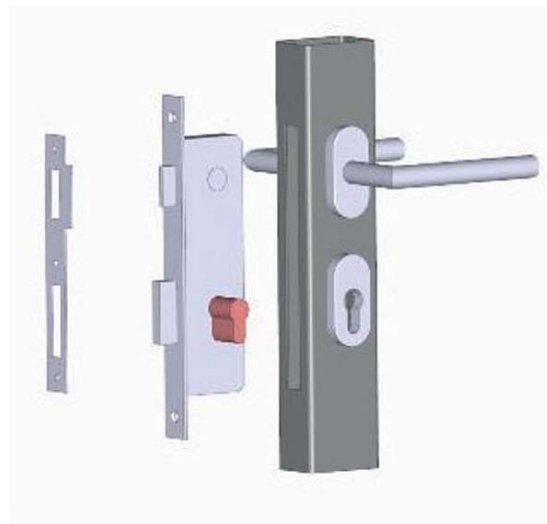

Stainless steel handle - 3 keys supplied



Classic Garden Elements®

This is special work for hard landscape gardeners **Garden arches with gates that need to be cemented into the ground**

A Classic Garden Elements garden arch with gate is an incredibly sturdy and stormproof structure, assuming you install it correctly.

Tips for assembling and installing a garden arch with gate

Firstly, you need to assemble the garden arch including the ground anchors but without the gate. A process best carried out when the structure is lying on the ground. The individual pieces of the arch and gate must first be inserted into one another using a simple connecting system. Once the structure has been assembled, you then insert and tighten a number of screws that hold everything firmly in place. When you have finished, these screws will be invisible and serve only to give the structure its stability.

Then you need to dig the holes for the foundations. Dig four holes in the ground where you want your garden arch with gate to stand. They need to be around 80 cm deep. Then fill the holes with about 20 cm of drainage material – something like fine gravel, for example – so that in the end the holes will be around 60 cm deep: The ground anchors are 50 cm long. Compress the gravel using an earth rammer. Now position the garden arch into the pre-prepared holes. Use a laser spirit level to ensure that everything is vertical.

Next you need to fix the garden arch in place so that it cannot move, using large stones and wooden supports. When it's secure and in the perfect position attach the gate to the arch. Test whether or not the gate opens, closes and locks correctly. It needs to move smoothly and not stick anywhere. When all is perfect with your garden arch with gate only then pour quick-setting concrete into the holes. Leave the concrete to cure, which usually takes around three days. Make sure you leave the supports in place as the concrete hardens.

Last you place the central fixing spike into the soil where the door gates meet. We recommend to do it first without concrete, and later, when you are happy how it works with the garden gate, fix it with concrete.

And that's it!